

FITTING INSTRUCTION

Clamp mark in acc. with		Cables joining
ISO	PN	
1	L	Left directional lights
2	+	Rear fog lights
3	31	Ground
4	R	Right directional lights
5	58R	Right side parking lights
6	54	Stoplights
7	58L	Left side parking lights

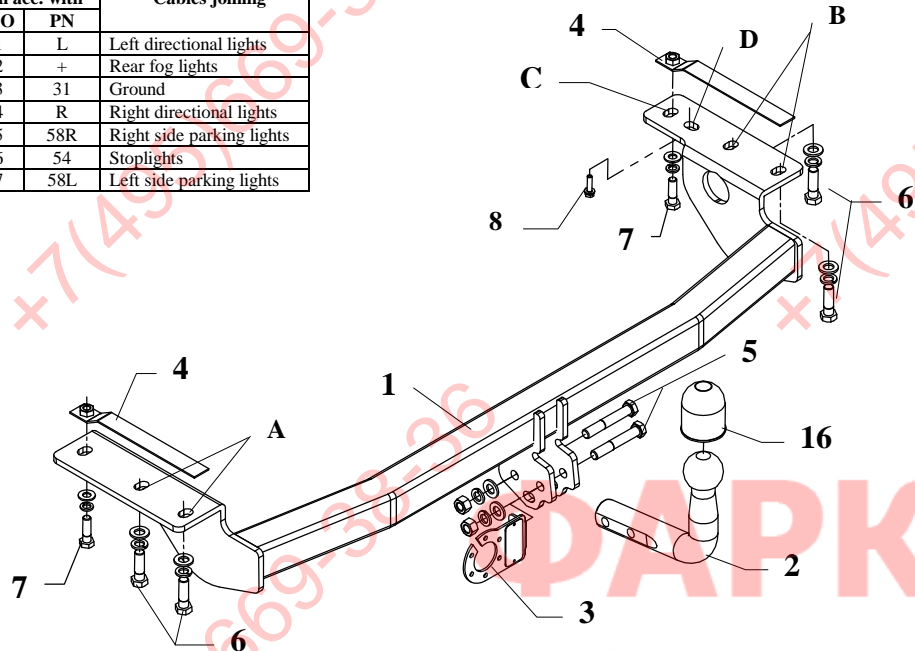

This towbar is designed to assembly in following car:
TOYOTA COROLLA ESTATE CAR produced since 01.2002 till 2007,
 catalogue no. **O52** and is prepared to tow trailers max total weight **1350 kg** and
 max vertical load **55 kg**.

From manufacturer

Thank you for buying our product. Their reliability has been confirmed in many tests. Reliability of towbar depends also on correct assembly and right operation. For this reasons we kindly ask to read carefully this instruction and apply to hints.

The towbar should be install in points described by a car producer.

Torque settings for nuts and bolts (8,8):	
M 8 - 25 Nm	M 10 - 55 Nm
M 12 - 85 Nm	M 14 - 135 Nm

The instruction of the assembly

1. Disassemble the rear bumper together with the plastic part.
2. Unscrew the towing eye and metal bumper reinforcement.
3. Disassemble the silencer and thermal plate.
4. Position the element (pos. 1) together with the towing eye to the car frame (do it such a way that towbar holes pos. A and B cover original holes) and fix it using bolts M12x1,25x40mm (pos. 6).
5. Slide the special nuts M10 (pos. 4) (do it such a way that the nuts cover the holes pos. C) and fix it using M10x35mm (pos. 7).
6. Reassemble the thermal plate (use three original bolts but the fourth one which is positioned at hole pos. D is from the towbar equipment M6x25mm – pos. 8).
7. Reassemble the silencer and plastic part after cutting it according to the fig. 1 and 2.
8. Tighten all nuts and bolts according to the torque shown in the table.
9. Position the ball of towbar (pos. 2) with socket plate (pos. 3) and fix with M12x75mm (pos. 5) screws from the towbar accessories.
10. Connect the electric wires according to the instructions of the car.
11. Complete the paint cover of towbar (during the mounting paint cover could be destroyed).

Fig.1

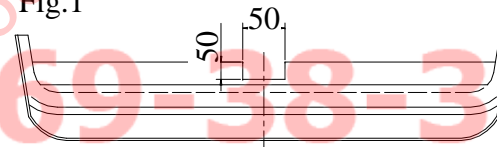

Fig.2



CUT











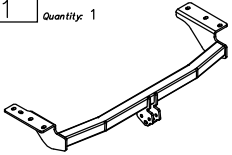
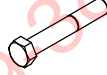



NOTE

After install the towbar you should get adequate note in registration book (at authorised service station).The car should be equipped with:

- Indicators
- Tow mirrors

After 1000km of exploitation check all bolts. The ball of towbar must be always kept clear and conserve with a grease.

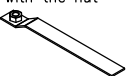
Towbar accessories:

Pos. 1 Name: Main bar Quantity: 1 	Pos. 5 Name: Bolt 8,8 B Quantity: 2 Dim.: M12x75mm 	Pos. 10 Name: Plain washer Quantity: 6 Dim.: Ø 13 mm 	Pos. 15 Name: Spring washer Quantity: 1 Dim.: Ø 6,2 mm 
	Pos. 6 Name: Bolt 8,8 B Quantity: 4 Dim.: M12x1,25x40mm 	Pos. 11 Name: Plain washer Quantity: 2 Dim.: Ø 10,5 mm 	Pos. 16 Name: Ball cover Quantity: 1 
Pos. 2 Name: Tow ball Quantity: 1 	Pos. 7 Name: Bolt 8,8 B Quantity: 2 Dim.: M10x35mm 	Pos. 12 Name: Plain washer Quantity: 1 Dim.: Ø 6,5 mm 	
Pos. 3 Name: Socket plate Quantity: 1 	Pos. 8 Name: Bolt 8,8 B Quantity: 1 Dim.: M6x25mm 	Pos. 13 Name: Spring washer Quantity: 6 Dim.: Ø 12,2 mm 	
Pos. 4 Name: Jib with the nut Quantity: 2 	Pos. 9 Name: Nut 8 B Quantity: 2 Dim.: M12 	Pos. 14 Name: Spring washer Quantity: 2 Dim.: Ø 10,2 mm 	

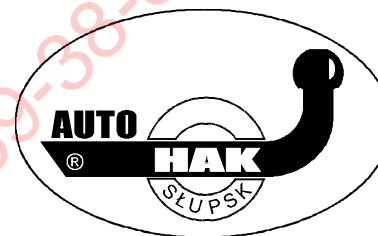

PPUH AUTO-HAK S. J.

Produkcja Haków Holowniczych
Henryk & Zbigniew Nejman
76-200 SŁUPSK ul. Słoneczna 16K
tel/fax (059) 8-414-414; 8-414-413
E-mail: office@autohak.com.pl
www.autohak.com.pl

Towing hitch (without electrical set)

Class: **A50-X** Cat. no. **O52**

Designed for:

Manufacturer: **TOYOTA**

Model: **COROLLA**

Type: **ESTATE**

produced since 01.2002 till 2007

Approval number acc. to regulations EKG/ONZ 55.01: **E20-55R-01 0791**

Technical data:

D-value: 7,65 kN

maximum trailer weight: **1350 kg**

maximum vertical cup load: **55 kg**

Foreword

This towbar is designed according to rules of safety traffic regulations. The towing hitch is a safety component and must be installed only by qualified personnel. Any alteration or conversion to the towing hitch is prohibited and would lead to cancellation of design certification. Remove insulating compound and underseal from vehicle (if present) in the area of the matting surfaces of the towing hitch. The vehicle manufacturer's specifications regarding trailer load and max. vertical cup load are decisive for driving, and values for the towing hitch cannot be exceeded.

D-value formula:

$$\frac{\text{Max trailer weight [kg]} \times \text{Max vehicle weight [kg]}}{\text{Max trailer weight [kg]} + \text{Max vehicle weight [kg]}} \times \frac{9,81}{1000} = D \text{ [kN]}$$